

## DIN W48×H48mm Star-Delta Timer

### ■ Features

- Realization of wide range of power supply  
: 100-240VAC 50/60Hz, 24-240VDC universal
- Wide range of setting time and switching time
  - T1 (setting time): Selectable 0.5 to 100 sec
  - T2 (switching time): Selectable 0.05, 0.1, 0.2, 0.3, 0.4, 0.5 sec
- Simple setting time, switching time operation
- Easy to check output status by LED display
- Application: Starting large capacity motors



**⚠ Please read "Safety Considerations" in the instruction manual before using.**



### ■ Ordering Information

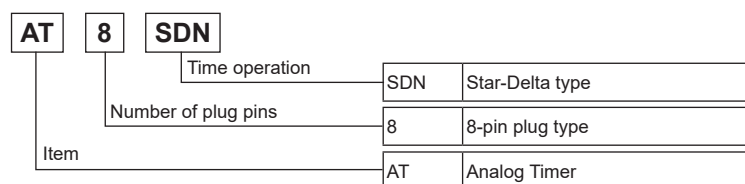

※8-pin socket (PG-08, PS-08(N)) is sold separately.

### ■ Specifications

Model	<b>AT8SDN</b>	
Function	<b>Star-Delta timer</b>	
Control time setting range <sup>※1</sup>	0.5 to 100 sec	
Power supply	100-240VAC~ 50/60Hz, 24-240VDC= universal	
Allowable voltage range	90 to 110% of rated voltage	
Power consumption	Max. 3.2VA (100-240VAC~), Max. 1.5W (24-240VDC=)	
Return time	Max. 100ms	
Timing operation	Power ON start type	
Control output	Contact type	λ contact: SPST (1a), Δ contact: SPST (1a)
	Contact capacity	250VAC~ 5A, 30VDC= 5A resistive load
Relay life cycle	Mechanical	Min. 10,000,000 operations
	Electrical	Min. 100,000 operations (250VAC 5A resistive load)
Repeat error	Max. ±0.2 % ±10ms	
λSetting error	Max. ±5% ±50ms	
Voltage error	Max. ±0.5%	
Temperature error	Max. ±2%	
λ-Δ Switching time error	Max. ±25%	
Insulation resistance	Over 100MΩ (at 500VDC megger)	
Dielectric strength	2,000VAC 50/60Hz for 1 min	
Noise immunity	±2kV the square wave noise (pulse width: 1μs) by the noise simulator	
Vibration	Mechanical	0.75mm amplitude at frequency of 10 to 55Hz (for 1 min) in each X, Y, Z direction for 1 hour
	Malfuction	0.5mm amplitude at frequency of 10 to 55Hz (for 1 min) in each X, Y, Z direction for 10 min
Shock	Mechanical	300m/s <sup>2</sup> (approx. 30G) in each X, Y, Z direction for 3 times
	Malfuction	100m/s <sup>2</sup> (approx. 10G) in each X, Y, Z direction for 3 times
Environment	Ambient temperature	-10 to 55°C, storage: -25 to 65°C
	Ambient humidity	35 to 85%RH
Approval	<b>CE c UL US</b>	
Accessory	Bracket	
Unit weight	Approx. 90g	

※1: Refer to time specifications for control time setting range.

※Environment resistance is rated at no freezing or condensation.

SENSORS
CONTROLLERS
MOTION DEVICES
SOFTWARE

(J) Temperature Controllers
(K) SSRs
(L) Power Controllers
(M) Counters
(N) Timers
(O) Digital Panel Meters
(P) Indicators
(Q) Converters
(R) Digital Display Units
(S) Sensor Controllers
(T) Switching Mode Power Supplies
(U) Recorders
(V) HMIs
(W) Panel PC
(X) Field Network Devices

# AT8SDN

## ■ Connections

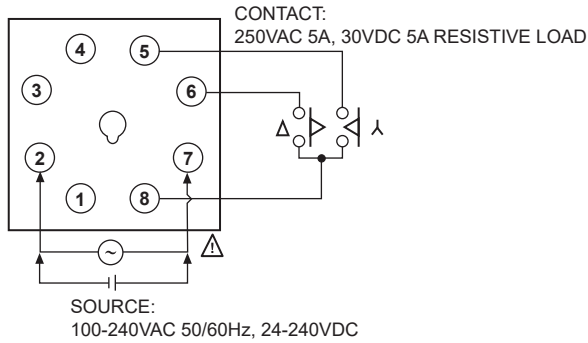

## ■ Dimensions

(unit: mm)

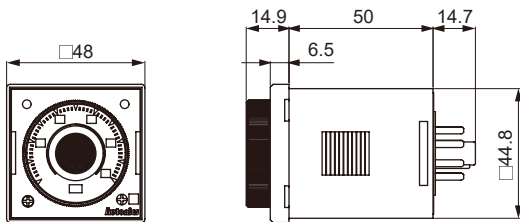

## ○ Bracket

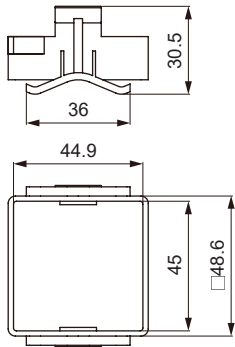

## ○ Panel cut-out

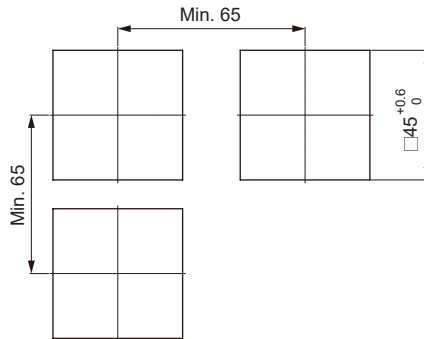

## ■ Unit Description

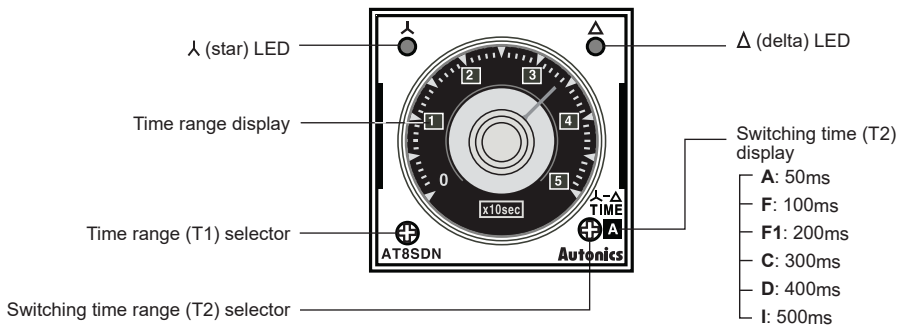

# Star-Delta Analog Timer

## Time Specifications

### 1. T1 (setting time)

Time range	Time unit	Time setting range
0.5	10 SEC	0.5 to 5 sec
1		1 to 10 sec
5		5 to 50 sec
10		10 to 100 sec

### 2. T2 ( $\lambda$ - $\Delta$ switching time)

(unit: sec)

Display	A	F	F1	C	D	I
T2 ( $\lambda$ - $\Delta$ switching time)	0.05	0.1	0.2	0.3	0.4	0.5

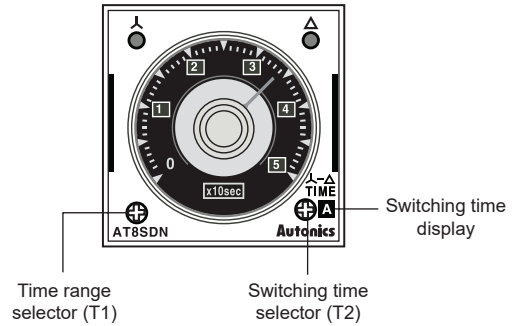

## Output Operation Mode

$\lambda$  contact will be ON as soon as power is supplied,  $\lambda$  contact will be OFF when T1 setting time is up then  $\Delta$  contact will be ON after T2 switching time is up.  $\Delta$  contact will be OFF when cut off the power at the status of  $\Delta$  contact is ON.

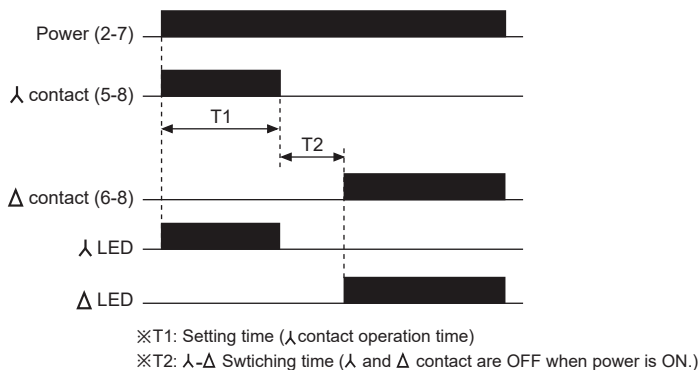

## Proper Usage

- Follow instructions in 'Proper Usage'. Otherwise, it may cause unexpected accidents.
- When supplying or turning off the power, use a switch or etc. to avoid chattering.
- Install a power switch or circuit breaker in the easily accessible place for supplying or disconnecting the power.
- In order to avoid leakage current flowing, connect resistance and condenser as (Figure 2).
- If connect as (Figure 1), it may cause malfunction due to leakage current.

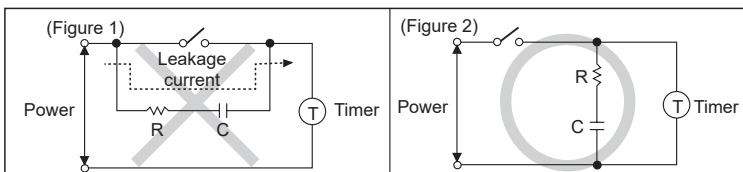

- Keep away from high voltage lines or power lines to prevent inductive noise.  
In case installing power line and input signal line closely, use line filter or varistor at power line and shielded wire at input signal line.  
Do not use near the equipment which generates strong magnetic force or high frequency noise.
- Change setting time(T1),  $\lambda$ - $\Delta$  switching time or etc. after turning off the power of the timer.
- This product may be used in the following environments.
  - Indoors (in the environment condition rated in 'Specifications')
  - Altitude max. 2,000m
  - Pollution degree 2
  - Installation category II

SENSORS
CONTROLLERS
MOTION DEVICES
SOFTWARE
(J) Temperature Controllers
(K) SSRs
(L) Power Controllers
(M) Counters
(N) Timers
(O) Digital Panel Meters
(P) Indicators
(Q) Converters
(R) Digital Display Units
(S) Sensor Controllers
(T) Switching Mode Power Supplies
(U) Recorders
(V) HMIs
(W) Panel PC
(X) Field Network Devices