

FSE Series

DIN W48 × H48mm Digital timer

■ Features

- Wide range of the time selection (0.01sec ~ 9999.9 hour)
- Power supply : 100–240VAC 50/60Hz, 12–24VAC/DC (Option)
- Memory protection : 10years
(When using non-volatile semiconductor memory)
- Built-in Microprocessor
- 8 Pin plug connection type

⚠ Please read "Caution for your safety" in operation manual before using.



■ Ordering information

FS	4	E		
				Single preset
			I	Indicator
			E	Timer
			4	9999(Digit)
			5	99999(Digit)
			FS	Series(FSE)

■ Specifications

Model		FS4E	FS5EI
Function		Single preset Up/Down Timer	Up/Down indicator
Character size		W4 × H8mm	
Power supply		100–240VAC 50 /60Hz, 12–24VAC/DC	
Allowable voltage range		90 ~ 110% of rated voltage	
Power consumption		Approx. 4.5VA (240VAC 60Hz), Approx. 2.5W (24VDC)	Approx. 3.5VA (240VAC 60Hz), Approx. 2.2W (24VDC)
Reset time		Max. 500ms	
Min. input signal width	RESET input	Approx. 20ms	
	INHIBIT input		
Input	RESET input	No-voltage input Impedance at short-circuit : Max. 470Ω, Residual voltage at short-circuit : Max. 1VDC Impedance at open circuit: Min. 100kΩ	
	INHIBIT input		
One-shot output time		0.05~5sec	
Control output	Contact type	Time-limit SPDT(1c)	—————
	Contact capacity	250VAC 3A at resistive load	—————
Relay life cycle	Mechanical	Min. 10,000,000 times	—————
	Electrical	Min. 100,000 times(250VAC 3A resistive load)	—————
Memory protection		10 years(When using non-volatile semiconductor memory)	
Repeat error		Max. ±0.01% ±0.05sec	
SET error			
Voltage error			
Temperature error			
Insulation resistance		100MΩ (at 500VDC mega)	
Dielectric strength		2000VAC 50/60Hz for 1 minute	
Noise strength	AC power	±2kV the square wave noise(pulse width:1μs) by the noise simulator	
	DC power	±500V the square wave noise(pulse width:1μs) by the noise simulator	
Vibration	Mechanical	0.75mm amplitude at frequency of 10 ~ 55Hz in each of X, Y, Z directions for 1hour	
	Malfunction	0.5mm amplitude at frequency of 10 ~ 55Hz in each of X, Y, Z directions for 10 minutes	
Shock	Mechanical	300m/s ² (Approx. 30G) in X, Y, Z directions 3 times	
	Malfunction	100m/s ² (Approx. 10G) in X, Y, Z directions 3 times	
Ambient temperature		-10 ~ +55℃ (at non-freezing status)	
Storage temperature		-25 ~ +65℃ (at non-freezing status)	
Ambient humidity		35~85%RH	
Unit weight	AC power	Approx. 122g	Approx. 112g
	DC power	Approx. 130g	Approx. 120g

8 Pin Plug Digital Timer

Connections

FS4E

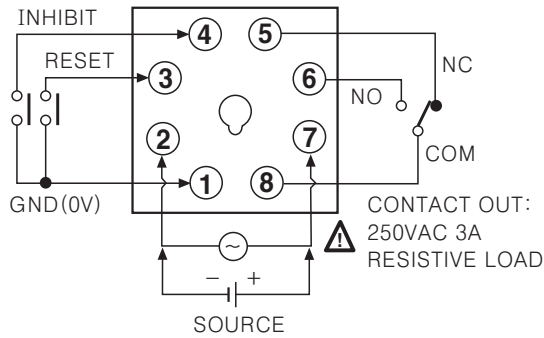

FS5EI

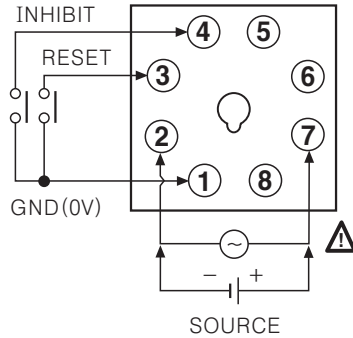

Input connections

◎Solid-state input

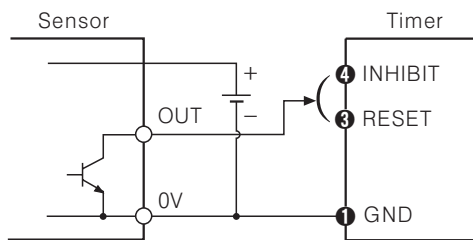

- Transistor ON → INHIBIT, RESET
- NPN open collector output sensor

※ Above numbers are terminal block.

◎Contact input

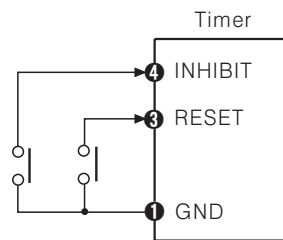

- Contact ON → INHIBIT, RESET
- Limit switch, Micro switch, Relay contact
- Please use reliable contacts enough to flow 5VDC 1mA of current.

Dimensions

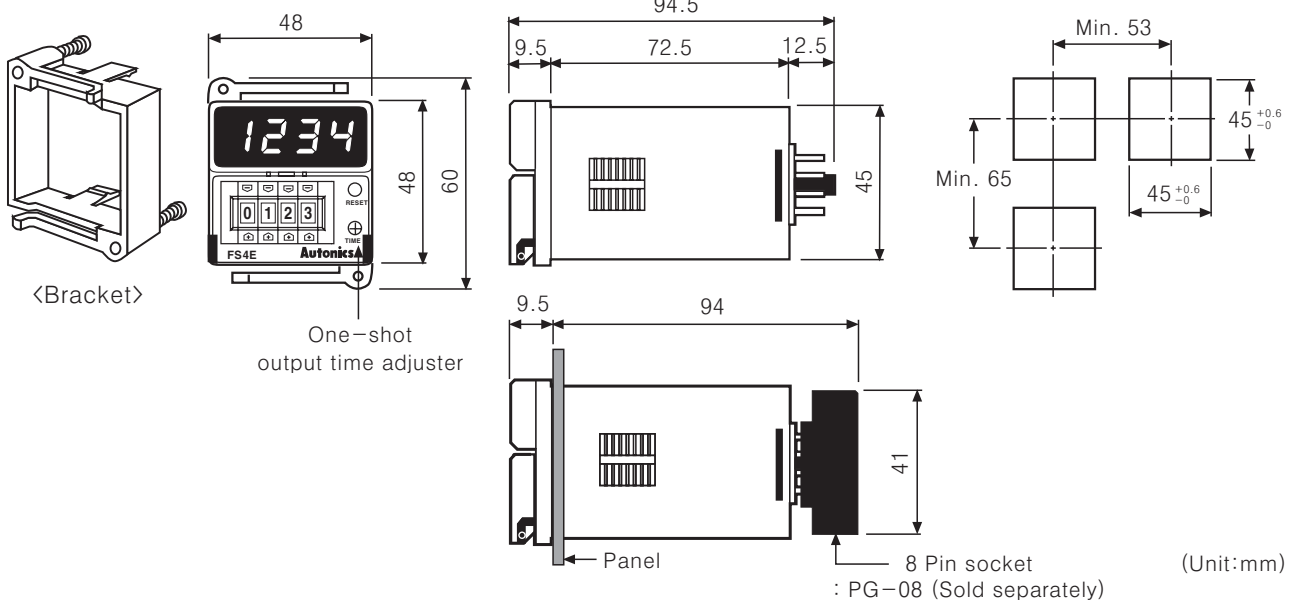

Case detachment

Please cut off the power and detach the case from body.

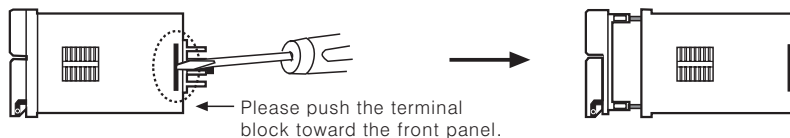

Please widen the Lock of product with driver and push it toward the front panel with, it will be detached.

※ Please be careful of the injury cause by tools.

(A)
Counter

(B)
Timer

(C)
Temp. controller

(D)
Power controller

(E)
Panel meter

(F)
Tacho/ Speed/ Pulse meter

(G)
Display unit

(H)
Sensor controller

(I)
Switching power supply

(J)
Proximity sensor

(K)
Photo electric sensor

(L)
Pressure sensor

(M)
Rotary encoder

(N)
Stepping motor & Driver & Controller

(O)
Graphic panel

(P)
Field network device

(Q)
Production stoppage models & replacement

FSE Series

Time operation of indication type

Up mode

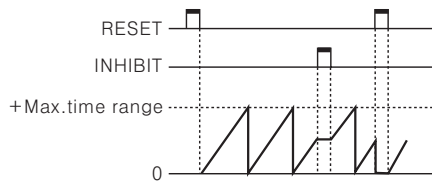

Down mode

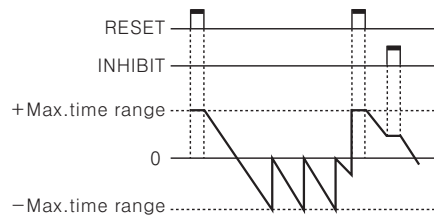

Description of inner DIP switches

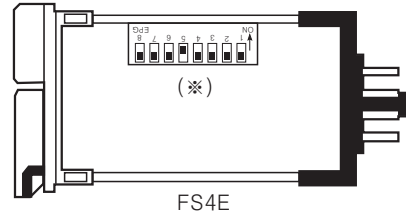
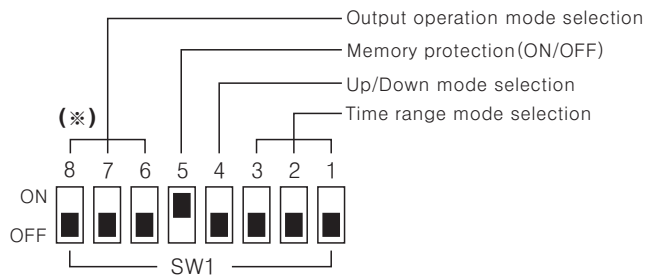

※ In case of indicator (FS5EI), 5 Pin DIP switch is included, because there is no output operation mode.

※ As upgraded model do not have unnecessary functions (No.5 : Timer, No.6 : NC), inner DIP switch is changed as 8 Pin.

Up/Down mode

SW1	Function
ON OFF	Down mode
ON OFF	Up mode

Memory protection























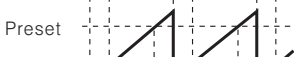

















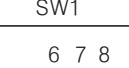







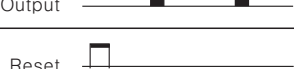



























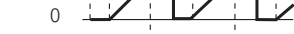

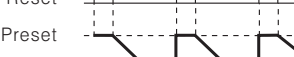













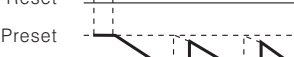
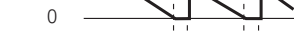







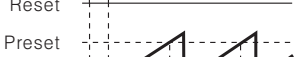









SW1	Function
ON OFF	Disable the memory protection
ON OFF	Enable the memory protection

Time range mode

Model	FS4E	FS5EI
SW1 ON OFF 1 2 3	99.99sec	9999.9sec
ON OFF 1 2 3	999.9sec	99999sec
ON OFF 1 2 3	9999sec	9min 59.99sec
ON OFF 1 2 3	99min 59sec	99min 59.9sec
ON OFF 1 2 3	999.9min	9999.9min
ON OFF 1 2 3	99hour 59min	9hour 59min 59sec
ON OFF 1 2 3	999.9hour	999hour 59sec
ON OFF 1 2 3	9999hour	9999.9hour

8 Pin Plug Digital Timer

FS4E Output operation mode

 ← One-shot output(0.05 ~ 5sec.)  ← Remained output			
Mode	ON  Up mode OFF 	ON  Down mode OFF 	Operation after time up
F SW1 6 7 8 ON    OFF   	Reset  Preset  0  Output 	Reset  Preset  0  Output 	The display value continues until Reset signal applied and the output will be held.
N SW1 6 7 8 ON    OFF   	Reset  Preset  0  Output 	Reset  Preset  0  Output 	The display value and output will be held until Reset signal.
C SW1 6 7 8 ON    OFF   	Reset  Preset  0  Output 	Reset  Preset  0  Output 	The processing time restarts at the same time when reset automatically regardless of output. The output is one-shot.
R SW1 6 7 8 ON    OFF   	Reset  Preset  0  Output 	Reset  Preset  0  Output 	The process time will be held until output is OFF and restarts at the same time when reset automatically. The output is one-shot.
K SW1 6 7 8 ON    OFF   	Reset  Preset  0  Output 	Reset  Preset  0  Output 	The time continues until Reset signal is applied. The output is one-shot.
P SW1 6 7 8 ON    OFF   	Reset  Preset  0  Output 	Reset  Preset  0  Output 	The processing time will be held until output is OFF and restarts at the same time when reset automatically. It progresses displaying one-shot output when restarting.
Q SW1 6 7 8 ON    OFF   	Reset  Preset  0  Output 	Reset  Preset  0  Output 	The processing time will be held until output is OFF and restarts at the same time when reset automatically. The output is one-shot.
S SW1 6 7 8 ON    OFF   	Reset  Preset  0  Output 	Reset  Preset  0  Output 	The output will be OFF and ON for setting time and repeats (flashing) this cycle.

※ Time Up : When processing time reaches to setting time.

※ Applying reset signal after time up, it will display zero for up mode and time range for down mode (displaying max. value in case of indication type).

(A) Counter

(B) Timer

(C) Temp. controller

(D) Power controller

(E) Panel meter

(F) Tacho/Speed/Pulse meter

(G) Display unit

(H) Sensor controller

(I) Switching power supply

(J) Proximity sensor

(K) Photo electric sensor

(L) Pressure sensor

(M) Rotary encoder

(N) Stepping motor & Driver & Controller

(O) Graphic panel

(P) Field network device

(Q) Production stoppage models & replacement

FSE Series

■ Proper usage

◎Preset value

Able to change setting value while it is running but setting value should be higher than previous setting value.

◎Power

- The inner circuit voltage starts to rise up for the first 100ms after power on, the input may not work at this time. And also the inner circuit voltage drops down for the last 500ms after power off, the input may not work at this time.

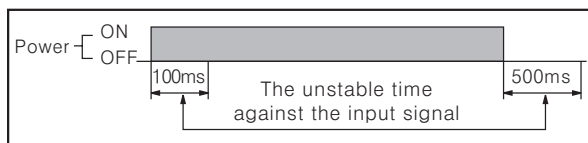

- Even though the power is applied, and the display does not turn on, please check the reset terminal.
- Please supply the power within rated power and apply or cut the power quickly to prevent chattering.

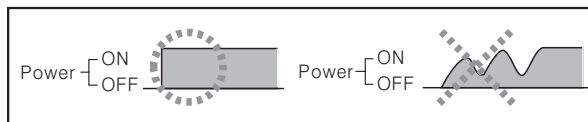

◎Input signal line

- Shorten the cable distance between the sensor and this product.
- Please use shield wire for input signal.
- Please wire input signal line separated from power line.

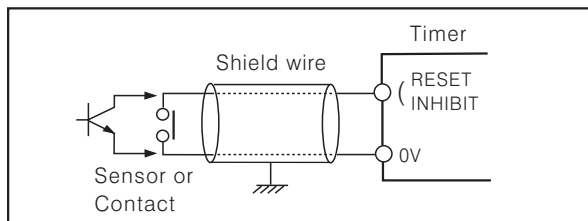

◎The reset signal width

It is reset perfectly when the reset signal is applied for max. 20ms regardless of the contact input & solid-state input.

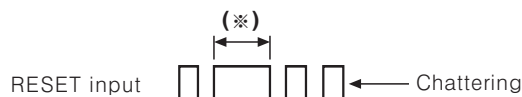

- (*) In case of a contact reset, it is reset perfectly if the ON time of reset signal is applied for max. 20ms even though a chattering is occurred.

◎Error

If setting value is "0000", "Err0" will be displayed. If setting value is changed to non-zero, this function is cancelled. However, the output in the status of Error signal will be OFF.

*The indicator does not have Error display function.

◎RESET

RESET has two function, which are memorizing DATA function and resetting output function.

When changing an inner selection switch, manual RESET or external RESET must be held after applying the power by all means. Otherwise, it will operate as previous mode. Selecting a RESET input/output mode again after applying power, please reset or reset manually, otherwise the previous mode will be operating.

◎INHIBIT

- When you need to check the real operating time, please use INHIBIT function.
- If you need to stop the time progressing, please use INHIBIT function.

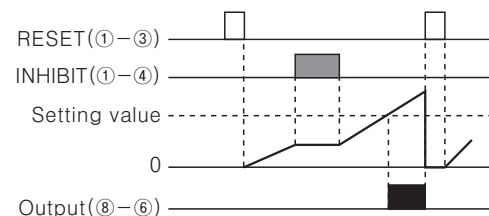

◎Environment

Please avoid the following places:

- Where this product may be damaged by strong impact or vibration.
- Where there are corrosive gas or flammable gas and water, oil, dust.
- Where magnetic and electrical noise occurs.
- Where there are High temperature and humidity beyond the rated specification.
- Where there are strong alkalis and acids.
- Where there are direct rays of sun.

◎Noise

- We test 2kV, Pulse width 1μs against Impulse voltage between power terminals and 1kV, pulse width 1μs at noise simulator against external noise voltage. Please install MP condenser (0.1~1μF) or oil condenser between power terminals when over Impulse noise voltage occurs.
- When testing dielectric voltage and insulation resistance of the control panel with this unit installed.

- ①Please isolate this unit from the circuit of control panel.
- ②Please make all terminals of this unit short-circuited.

- Sudden function stop while it is running (When displaying wrong numbers or nothing) In this case, please power off and turn on again. This is due to strong noise flows into this product therefore please try to separate inductive load from input signal line of this product or install surge absorber between inductive loads.