

SPC1 Series

■ Features

● Various and simple input specification

- DC4–20mA, 1–5VDC, External 24VDC
- External adjuster (1k Ω)
- External contact (ON/OFF)

● Various function

- Out ADJ (Limit the output) function
- Soft Start function (Except for ON/OFF control type)
- Out display function
- 50/60Hz automatic converting function

● Various control type by mode switches

- Phase control type
- Cycle control type (Zero Cross)
- ON/OFF control type (Zero Cross)



⚠ Please read "Caution for your safety" in operation manual before using.

■ Ordering information

SPC	1	—	35	
		Rated current	35	35A
			50	50A
		Constant	1	Single phase
		Series	SPC	Series name (Solid state Power Controller)

■ Specifications

Model		SPC1-35	SPC1-50
Power supply		220VAC 50/60Hz	
Allowable voltage range		90 ~ 110% of rated voltage	
Maximum rated current		35A	50A
Control power		220VAC	
Control range		0 ~ 100% (Except for triac voltage drop)	
Application load		Resistance load (Min. load : Over 5% of rated current)	
Cooling method		Natural cooling by heat sink	
Control circuit		Micom control type	
Control input		●1–5VDC ●DC4–20mA (250 Ω) ●ON/OFF (External relay contact) ●External adjuster (1k Ω) ●Output limit input (Inner adjuster) ●External 24VDC	
Control mode		Phase control Cycle control (Zero Cross) – Period 0.5sec, 2.0sec, 10sec selectable ON/OFF control (Zero Cross)	
Starting type		Soft Start (0~50 sec variable) – Only for phase control and cycle control	
Display		Output indication (LED)	
Insulation resistance		100M Ω (at 500VDC mega)	
Dielectric strength		2000VAC for 1minute	
Noise strength		± 2 kV the square wave noise (pulse width:1 μ s) by the noise simulator	
Vibration	Mechanical	0.75mm amplitude at frequency of 10 ~ 55Hz in each of X, Y, Z directions for 1hour	
	Malfuction	0.5mm amplitude at frequency of 10 ~ 55Hz in each of X, Y, Z directions for 10min.	
Shock	Mechanical	300m/s ² (30G) in X, Y, Z directions for 3 times	
	Malfuction	100m/s ² (10G) in X, Y, Z directions for 3 times	
Ambient temperature		0 ~ +50 $^{\circ}$ C (at non-freezing status)	
Storage temperature		–25 ~ +65 $^{\circ}$ C (at non-freezing status)	
Ambient humidity		35 ~ 85%RH	
Net weight		Approx. 1kg	

Power Controller

Dimensions

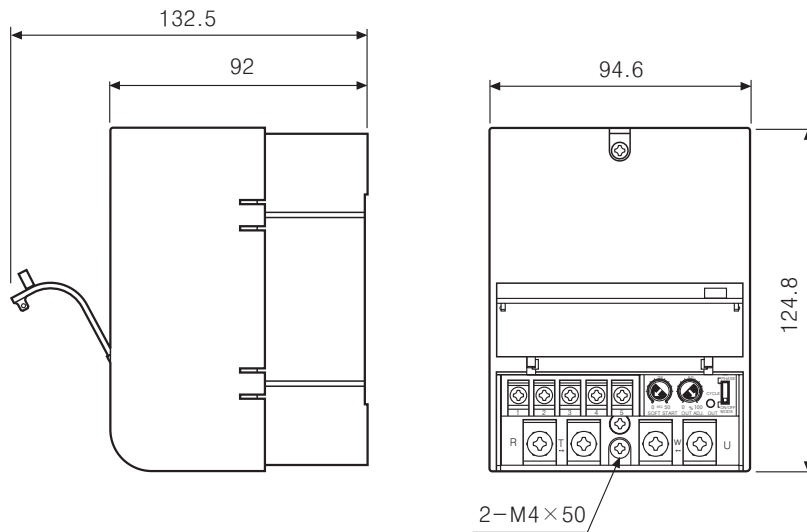

(Unit:mm)

Panel lay-out

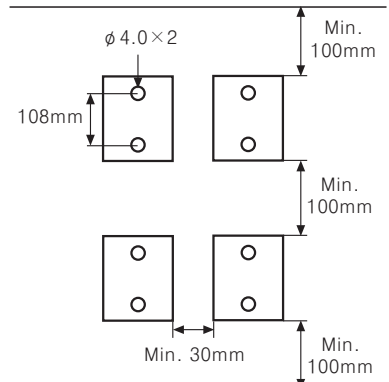

※It should have enough space between units for proper cooling.

Connections

1. External connection

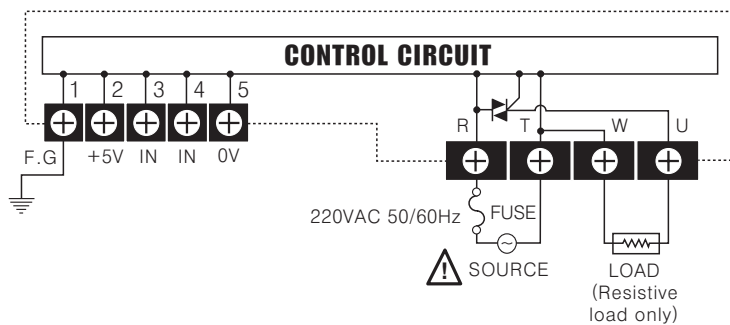

2. Connection of control input terminals

1)DC4-20mA control input

It controls 0 to 100% when you apply DC4-20mA on ④, ⑤ terminals when power is applied.

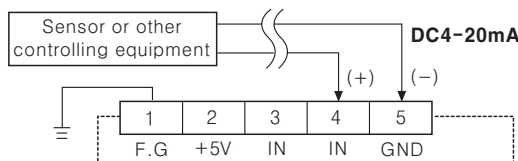

※ It is not available in ON/OFF control mode.

2)1-5VDC control input

It controls 0 to 100% when you apply 1 to 5VDC on ③, ⑤ terminals when power is applied.

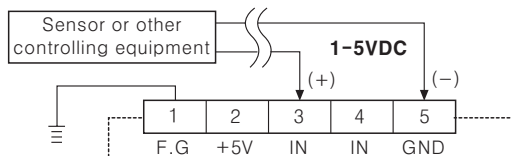

※ It is not available in ON/OFF control mode.

3)ON/OFF External contact control input

It controls 100% if you connect external switch or relay contact to ②, ③ terminal when it is ON, it controls 0% when it is OFF.

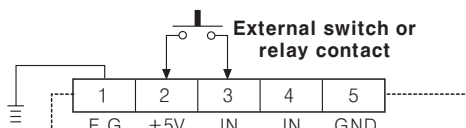

※ It is not available in ON/OFF control mode.
OUT ADJ and SOFT START function cannot be used in ON/OFF control mode.

(A)	Counter
(B)	Timer
(C)	Temp. controller
(D)	Power controller
(E)	Panel meter
(F)	Tacho/Speed/Pulse meter
(G)	Display unit
(H)	Sensor controller
(I)	Switching power supply
(J)	Proximity sensor
(K)	Photo electric sensor
(L)	Pressure sensor
(M)	Rotary encoder
(N)	Stepping motor & Driver & Controller
(O)	Graphic panel
(P)	Field network device
(Q)	Production stoppage models & replacement

SPC1 Series

4) External adjuster control input

After power is applied, connecting the external adjuster 1kΩ to ②, ③ and ④ terminals and turning adjuster control from 0% to 100%.

It is available to control as OUT ADJ, adjuster for the above 1), 2), 3) and set at 100% when it is not used.

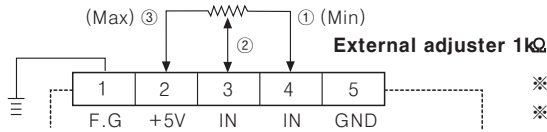

- ※ It cannot be used in ON/OFF control mode.
- ※ OUT ADJ, adjuster and SOFT START are not available to use.

5) External 24VDC control input

It can be used with external 24VDC voltage as below.

It is available to control of ON/OFF, outputs 100% for applying 24VDC and 0% for applying 0VDC.

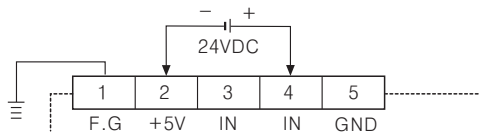

- ※ It cannot be used in ON/OFF control mode.
- ※ OUT ADJ, adjuster and SOFT START are not available to use.

■ Front panel identification

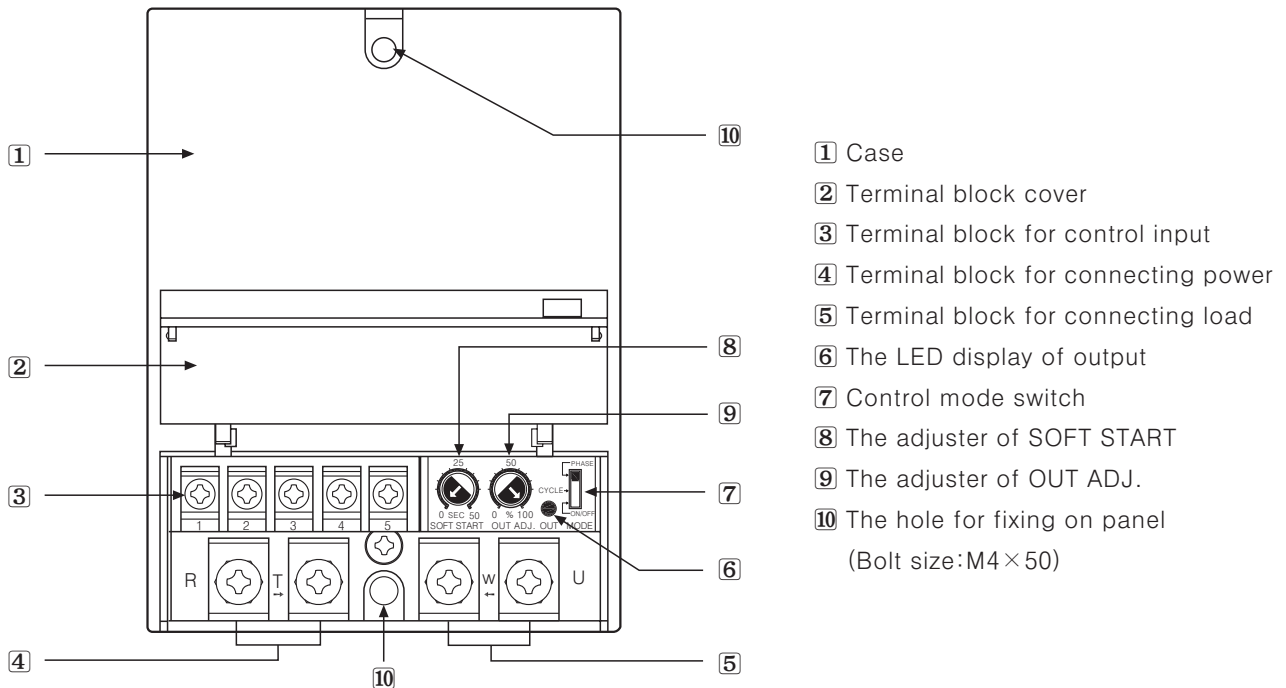

■ Factory Default setting

Control mode	Phase control mode
Control type	Phase equality division type according to control input
Control cycle	0.5sec
SOFT START setting	0sec
OUT ADJ. setting	100%

Operation and function

Front

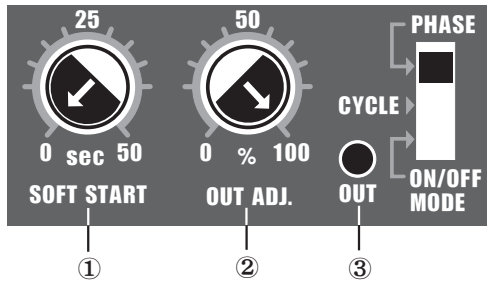

- ① SOFT START time setting adjuster(0 ~ 50sec.)
- ② Output limiting setting adjuster(0 ~ 100%)
- ③ Output operation display LED
- ④ Control mode switch
 - PHASE : Phase control mode
 - CYCLE : Cycle control mode
 - ON/OFF : ON/OFF control mode

Control mode selection

Control mode	Phase control mode	Cycle control mode (Zero Cross)	ON/OFF control mode (Zero Cross)
Mode switch			

- *When selecting cycle control mode, the cycle has been set as 0.5sec. It can be changed to 2.0sec., 10sec. by jumper function.
- *The mode cannot be changed while it is operating. Please be careful to set the proper mode **after turning the power off** then apply the power again.

1) Phase control

It is output type to control phase of an alternating signal according to control input signal.

- Equality division type of phase according as control input

This is analog type to output control angle with dividing equally according as control input signal. It shows power characteristic as (Fig. 1) and it might be occurred over power and lack power at point middle of control input.

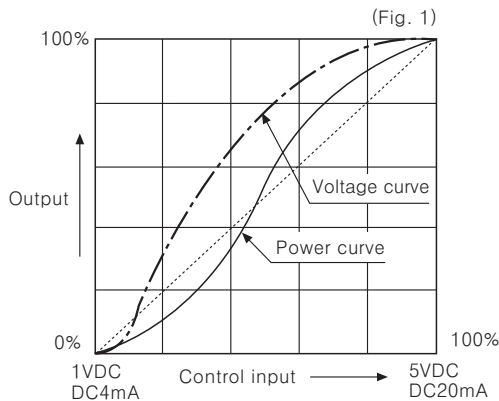

- Equality division type of power according as control input

It divides control angle non-equaly according as control input signal then make power curve linerize, so it becomes possible to output the power, which is proportioned control input as outputting(Fig. 1).

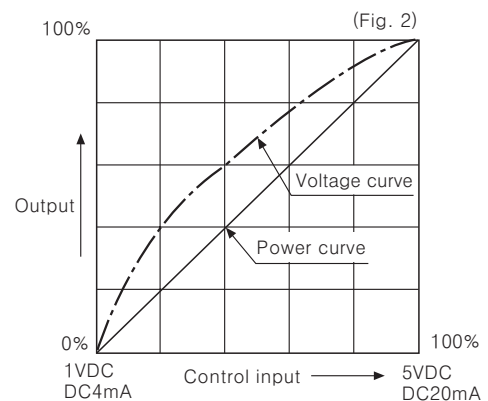

*To change the control method, change TP3 of PCB as below.

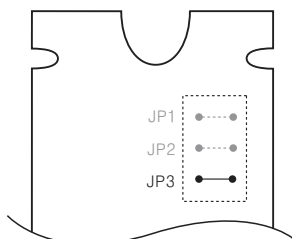

JP3	Division method(Control method)
SHORT	Equal division of phase according to control input
OPEN	Equal division of power according to control input

* SHORT OPEN

2) Cycle control-Zero Cross

It controls the power, which is applied into the load to repeat ON/OFF cycle like below picture with constant proportion according to control input signal. It is easy to control the load and there is no ON/OFF noise because it turns ON and OFF at the zero point of AC.

Usually it is used in a place or electric furnace which is not easily effected by external noise.

- (A) Counter
- (B) Timer
- (C) Temp. controller
- (D) Power controller
- (E) Panel meter
- (F) Tacho/Speed/Pulse meter
- (G) Display unit
- (H) Sensor controller
- (I) Switching power supply
- (J) Proximity sensor
- (K) Photo electric sensor
- (L) Pressure sensor
- (M) Rotary encoder
- (N) Stepping motor & Driver & Controller
- (O) Graphic panel
- (P) Field network device
- (Q) Production stoppage models & replacement

SPC1 Series

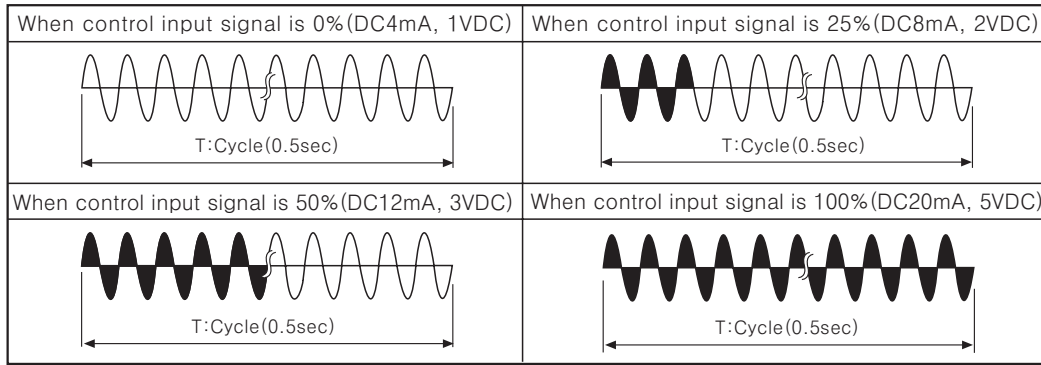

※ The left cycle waveform is shortened as 1/2 of real one. (30Hz)

※ To change the control method, change JP3 of PCB as below.

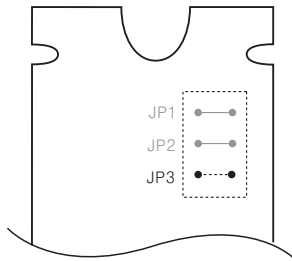

JP1	JP2	Cycle(sec)
SHORT	SHORT	0.5sec
SHORT	OPEN	2.0sec
OPEN	SHORT	10sec
OPEN	OPEN	X(Not used)

※  SHORT  OPEN

3) ON/OFF control-Zero Cross

This function is when control input is ON, output is 100%. When it is OFF, output is 0%. It is the same function as SSR(Solid State Relay).

※ It is not able to use OUT ADJ. and SOFT START function in ON/OFF control mode.

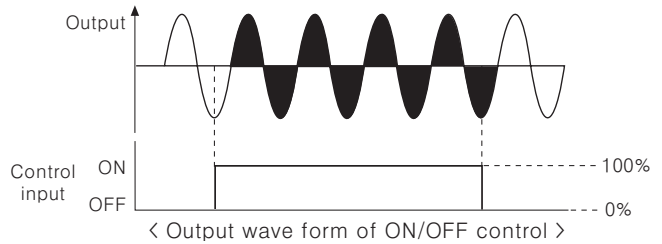

◎ OUT ADJ. function(0 to 100%)

This function will be as follows :
 $[\text{Control input}(\%) \times \text{OUT ADJ.}(\%) = \text{Output}]$
 and it controls the power applied into the load.
 Ex) Although the control input is 100% (5VDC or DC20mA), if OUT ADJ. is 50%, the output will be 50% which is proportioned with OUT ADJ. When this function is not used, OUT ADJ. should be 100%.

※ This function must not be used in ON/OFF control mode.

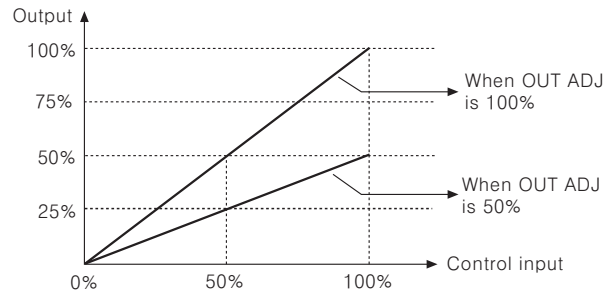

<The output characteristic of OUT ADJ. and control input>

◎ SOFT START function(0~50sec)

When the power is applied, this function is able to protect the load when it controls load(Molybdenum, White gold, tungsten, infrared Lamp) with inrush current or the width of rising temperature is big(SV is big).

When this function is not used, T should be "0".

Note) In this time, if you increase the OUT ADJ. before it reaches T/2, it will slowly increase and then reaches the new output in a total time period equal to T multiplied by the new OUT ADJ. percentage.

※ This function must not be used in ON/OFF control mode.

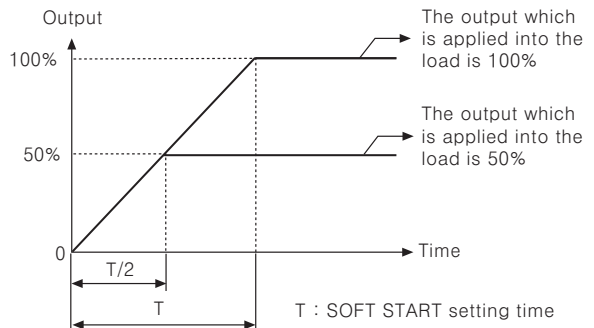

※ T : Time to get the output which is applied into the load is 100%.

T/2 : Time to get the output which is applied into the load is 50%.

◎ OUT display function

This is LED lamp to display the status of output and will be getting brighter according to output. (0% : Minimum, 100% : Maximum)

Application

Ex1) When it needs to control accurately by adjusting the power in phase control and cycle control mode.

For example, if it needs to control 80% output when it is ON, 24% output when it is OFF, please keep below.

Firstly set OUT ADJ. as 80% and connect external adjuster and external relay contact switch as above picture then set external adjuster as 30%.

●When the External contact signal is ON : $100\%(\text{External contact input}) \times 80\%(\text{Out ADJ.}) = 80\%$

●When the External contact signal is OFF : $30\%(\text{Adjuster input}) \times 80\%(\text{Out ADJ.}) = 24\%$

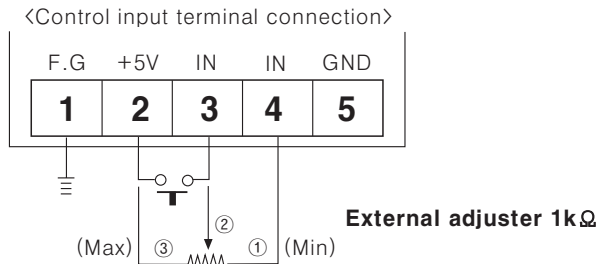

Ex2) This is how to control 0 to 100% without external adjuster in phase control mode and cycle control mode.

It is possible to control 0 to 100% by turning OUT ADJ. in state of connecting terminal 2 and terminal 3.

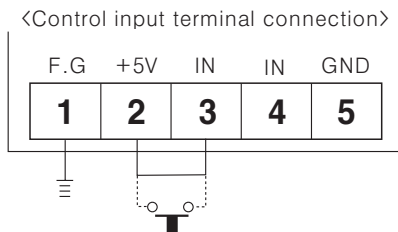

Proper usage

Warning

When using this item, ground F.G terminals to avoid an electric shock.

Do not touch the heat sink since it radiates high temperature.

Caution

- When you install it on panel, it should be installed vertically at the place, which is well ventilated.
If install it horizontally, under 70% of rated current should be applied, and a vent fan needs to be installed on the upper part of panel.
- Be careful to attach prompt fuse between R phase terminal and power.
- If over the maximum rated current, it causes product damage.
(Do not over maximum rated current when using high rush current.)
- Since it is only for resistive load, the inductive load cannot be used.
- When connecting power and load, please use the cable (When rated current is 35A: Min. 8.4mm², when rated current is 50A : Min. 13.3mm²) which is able to send the maximum rated current.
- Before using this unit, set the proper mode and function.
Especially, if the setting of Out ADJ. is 0%, it does not operate.
- The mode cannot be changed while it is operating.
Please be sure to set the proper mode after cutting the power off and then apply the power.
- Do not use this unit as following place.
 - A place where corrosive or inflammable gas is occurred.
 - A place where water and oil is occurred.
 - A place where there are a lot of dusts.
- Case detachment
Please turn off the power and detach the case.
 - Widen Lock device toward the outside with a driver.
 - Put the case up and separate it.

※Be careful to use machine tools,
it may cause an injury.

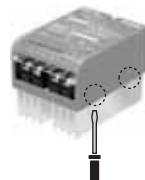

②Put the case up and separate it.



(A)	Counter
(B)	Timer
(C)	Temp. controller
(D)	Power controller
(E)	Panel meter
(F)	Tacho/ Speed/ Pulse meter
(G)	Display unit
(H)	Sensor controller
(I)	Switching power supply
(J)	Proximity sensor
(K)	Photo electric sensor
(L)	Pressure sensor
(M)	Rotary encoder
(N)	Stepping motor & Driver & Controller
(O)	Graphic panel
(P)	Field network device
(Q)	Production stoppage models & replacement